



STEEL STAR
www.greatforming.com



Plus de 15 ans d'expérience dans le domaine des machines de formage de rouleaux.



Des plans clairs, des prix clairs.
Créez le meilleur plan pour vous.

Machine de formage de rouleaux

Cangzhou Steelstar Machinery Co.,Ltd.

Contenu



Profil de l'entreprise



Expositions



Partenaires étrangers



STEEL STAR
www.greatforming.com

Contenu



Catalogue de produits

1. Machine de formage de rouleaux de tôles de toiture
2. Machine de formage de quille en acier pour plafond/cloison
3. Machine de formage de rouleaux de portes à volets
4. Machine de formage de rouleaux de pannes C/Z
5. Machine de formage de rouleaux de faîtage
6. Machine de formage de rouleaux ondulés à tambour transversal
7. Machine de formage de rouleaux de plancher en acier porteur
8. Machine de formage de tôles d'acier côté automobile
9. Machine de formage de rouleaux de gouttières et descentes pluviales



STEEL STAR
www.greatforming.com

Contenu



Catalogue de produits

10. Machine de formage de rouleaux de cadre de villa à quille légère
11. Machine de formage de rouleaux de plaques de garde-corps
12. Ligne de production de panneaux composites pour toitures en mousse/laine de roche
13. Machine de fabrication de panneaux de toiture à dérouleur/empileur automatique
14. Machine à cisailier/à cintrer
15. Machine de ligne de refendage de bobines d'acier
16. Machine de formage de rouleaux de supports solaires
17. Machine de fabrication de tubes en acier
18. Différents produits peuvent être personnalisés

Contenu



Expédition à l'étranger



Service



Contactez-nous



STEEL STAR
www.greatforming.com

Profil de l'entreprise

**L'usine s'étend sur une
superficie de 20 000 m²**

**Véritable usine de
production**

**Service en ligne 24 heures
sur 24**

**15 ans d'expérience dans
l'industrie**

**Coopération avec plus de
30 pays**

**Des plans clairs Des prix
clairs**

**Logiciel de conception de
coprah allemand**



**A de nombreux
partenaires étrangers**

**Obtention de plusieurs
certifications
internationales**



STEEL STAR
www.greatforming.com

Vue de l'usine de l'entreprise

Zone d'usine



Atelier d'usinage de matières premières



Atelier de production d'assemblage





STEEL STAR
www.greatforming.com

Certificat d'honneur de l'entreprise





STEEL STAR
www.greatforming.com

Expositions

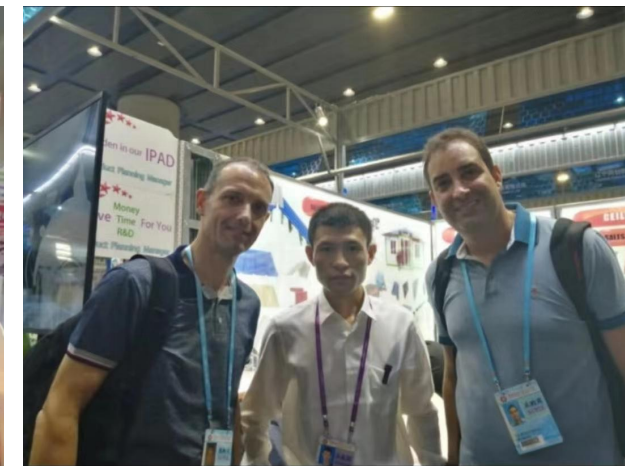
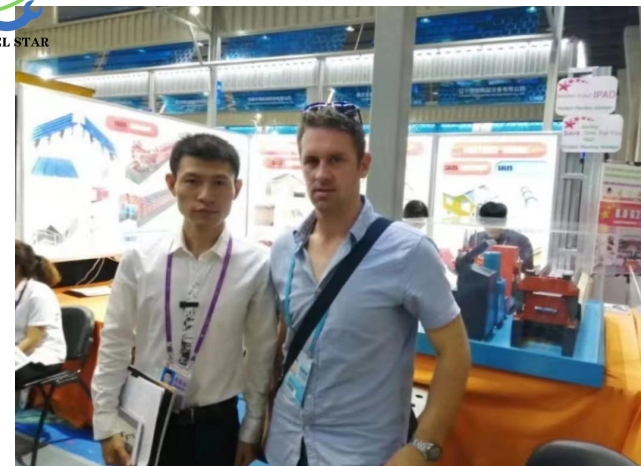
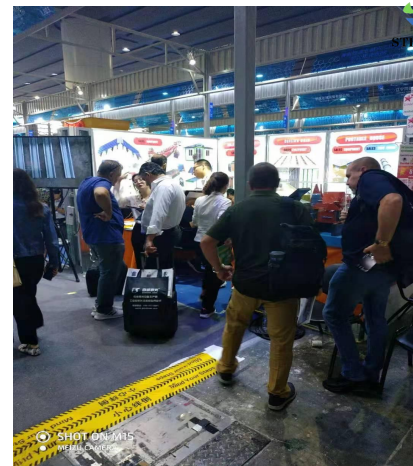
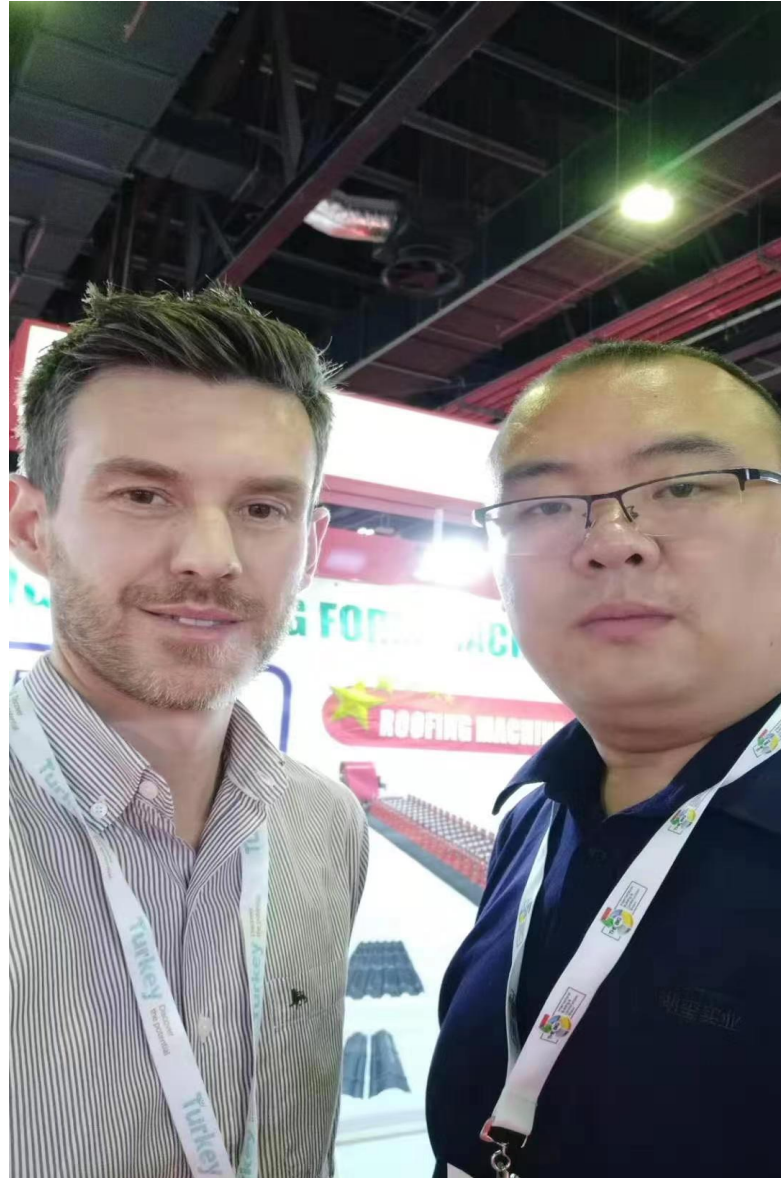



STEEL STAR
www.greatforming.com

Partenaires étrangers





STEEL STAR
www.greatforming.com

Catalogue de produits

1. Machine de formage de rouleaux de tôles de toiture

1-1 Machine de formage de rouleaux de tôles trapézoïdales à modèle unique

Scénarios d'application





STEEL STAR
www.greatforming.com

Catalogue de produits

1-1 Machine de formage de rouleaux de tôles trapézoïdales à modèle unique

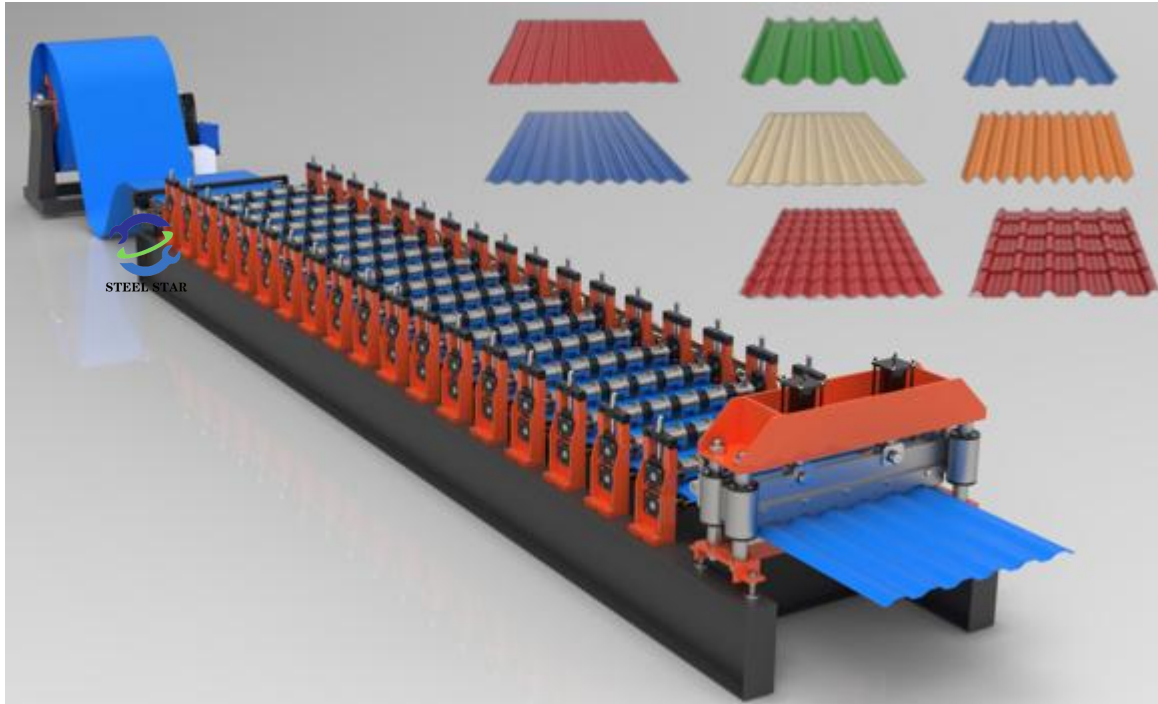

1. Machine de formage de rouleaux de tôles de toiture

Trapezoidal roofing sheet

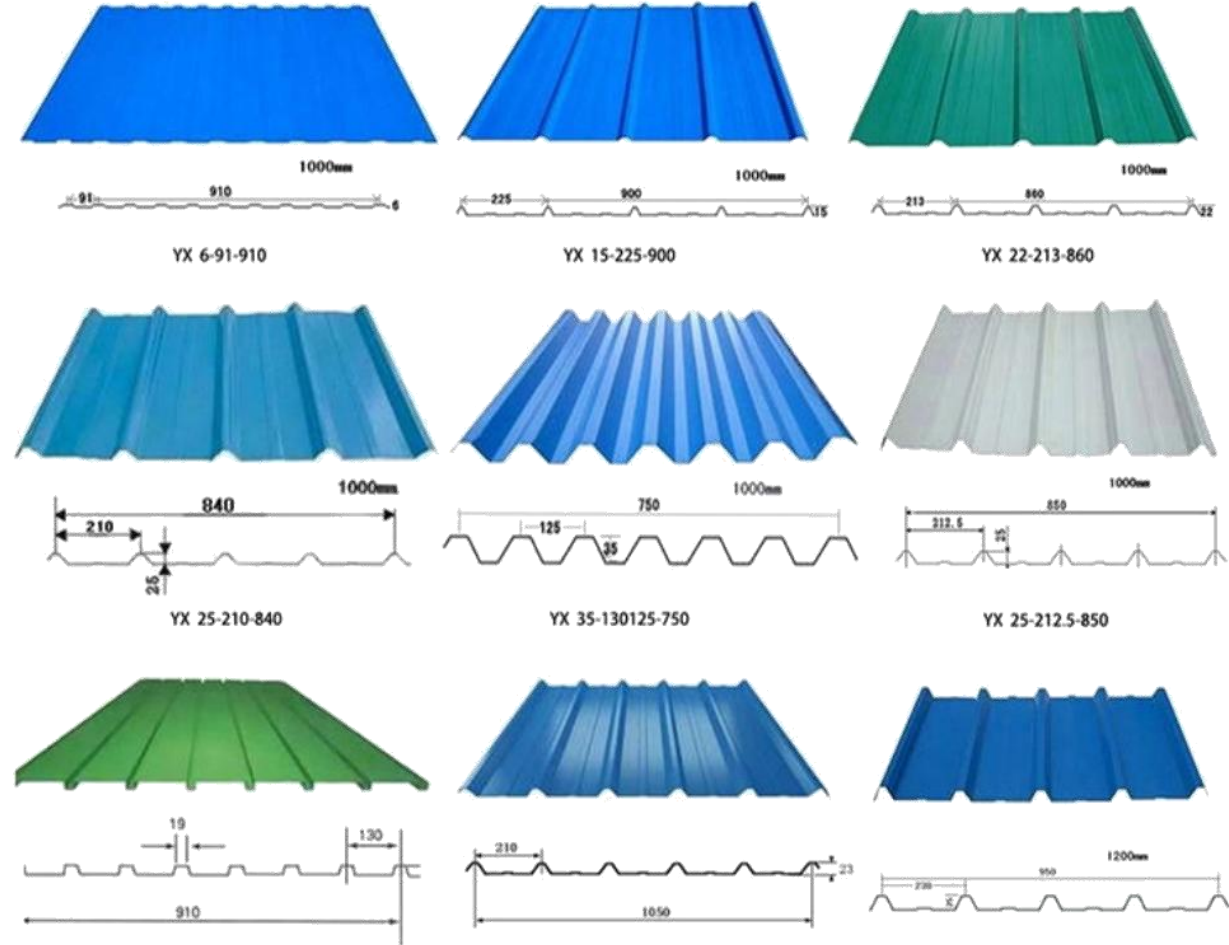



STEEL STAR
www.greatforming.com

Catalogue de produits

1. Machine de formage de rouleaux de tôles de toiture

1-2 Machine de formage de rouleaux de tôle ondulée à modèle unique

Scénarios d'application

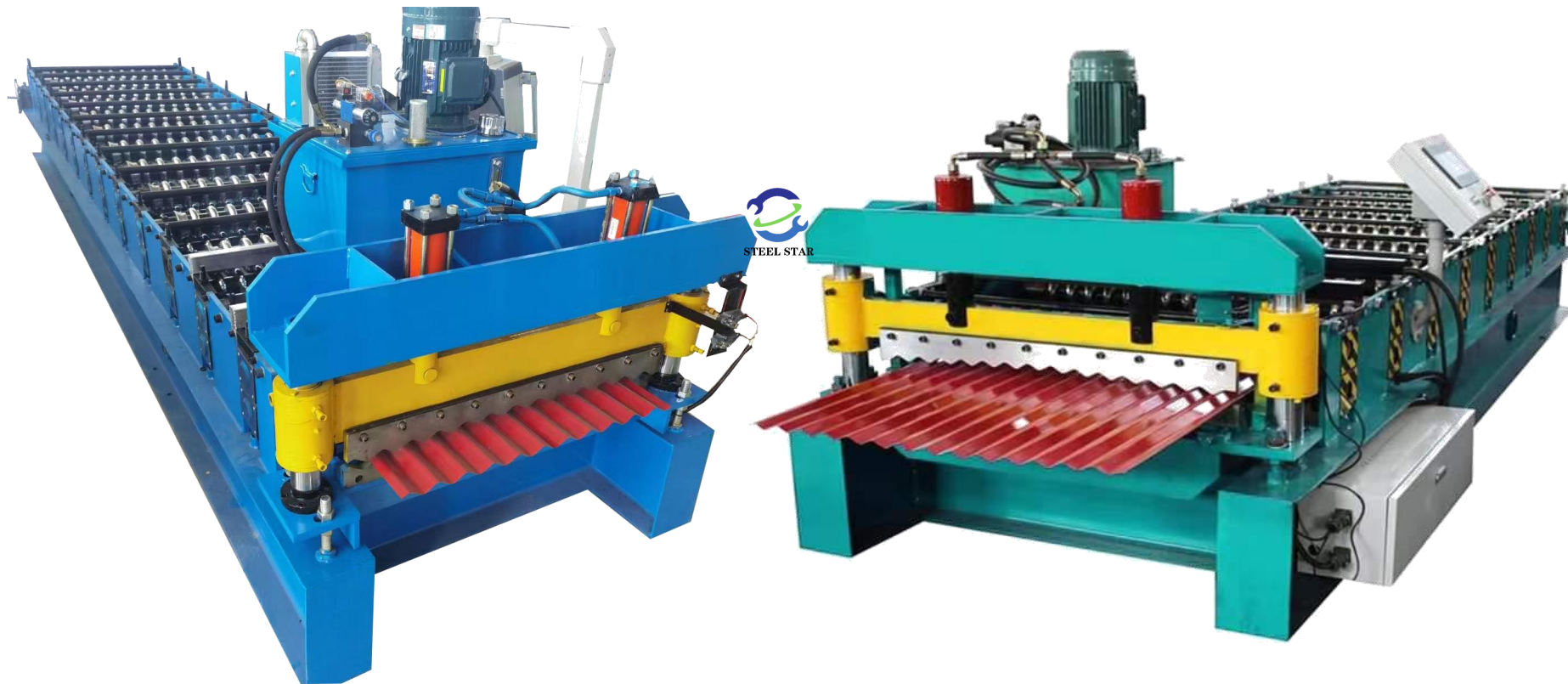



STEEL STAR
www.greatforming.com

Catalogue de produits

1. Machine de formage de rouleaux de tôles de toiture

1-2 Machine de formage de rouleaux de tôle ondulée à modèle unique

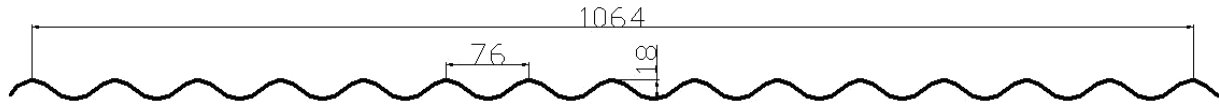

进料宽度: 1250mm

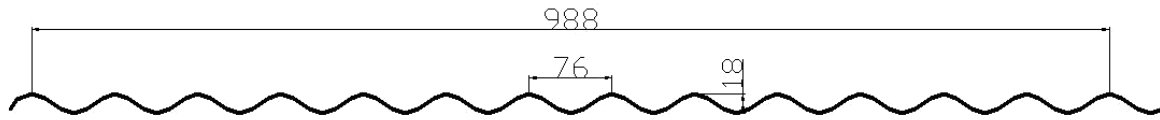

进料宽度: 1200mm

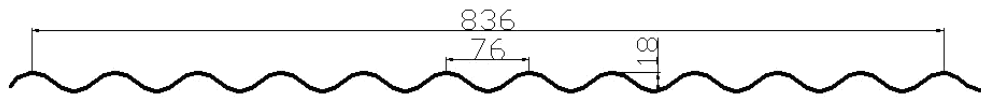

进料宽度: 1000mm

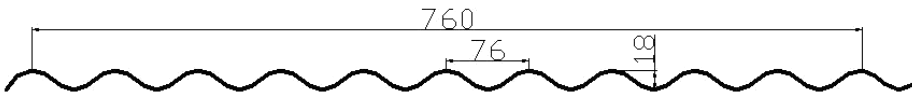

进料宽度: 940mm

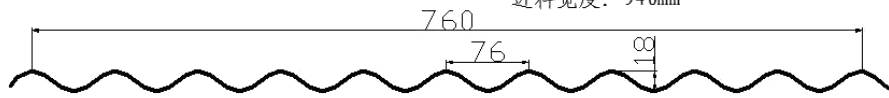

进料宽度: 914mm

Wave roofing sheet

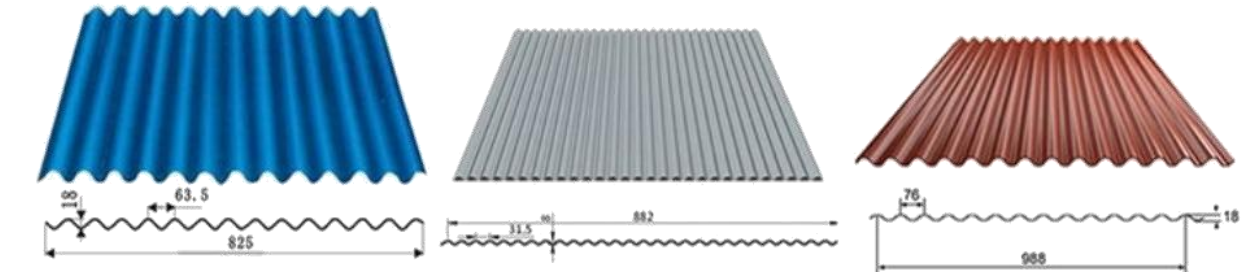

YX 18-63.5-825

YX 8-31.5-882

YX 18-76-988

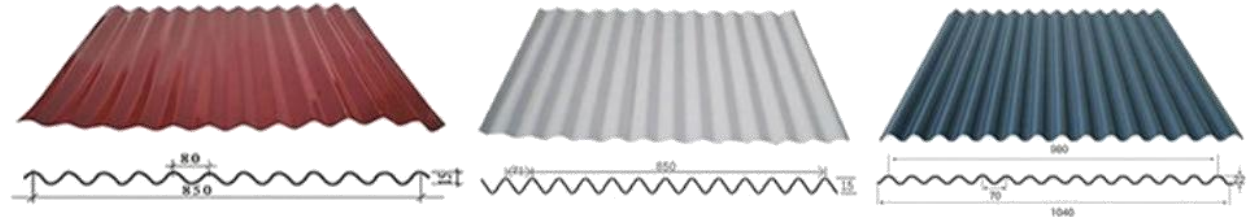

YX 15-80-850

YX 15-71-850

YX 22-70-980

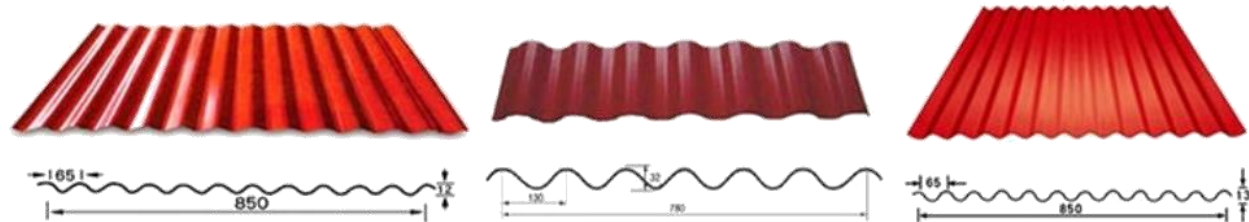

YX 12-65-850

YS 32-130-780

YS 13-65-850



STEEL STAR
www.greatforming.com

Catalogue de produits

1. Machine de formage de rouleaux de tôles de toiture

1-3 Machine de formage de rouleaux de tôles de toit en tuiles émaillées à modèle unique

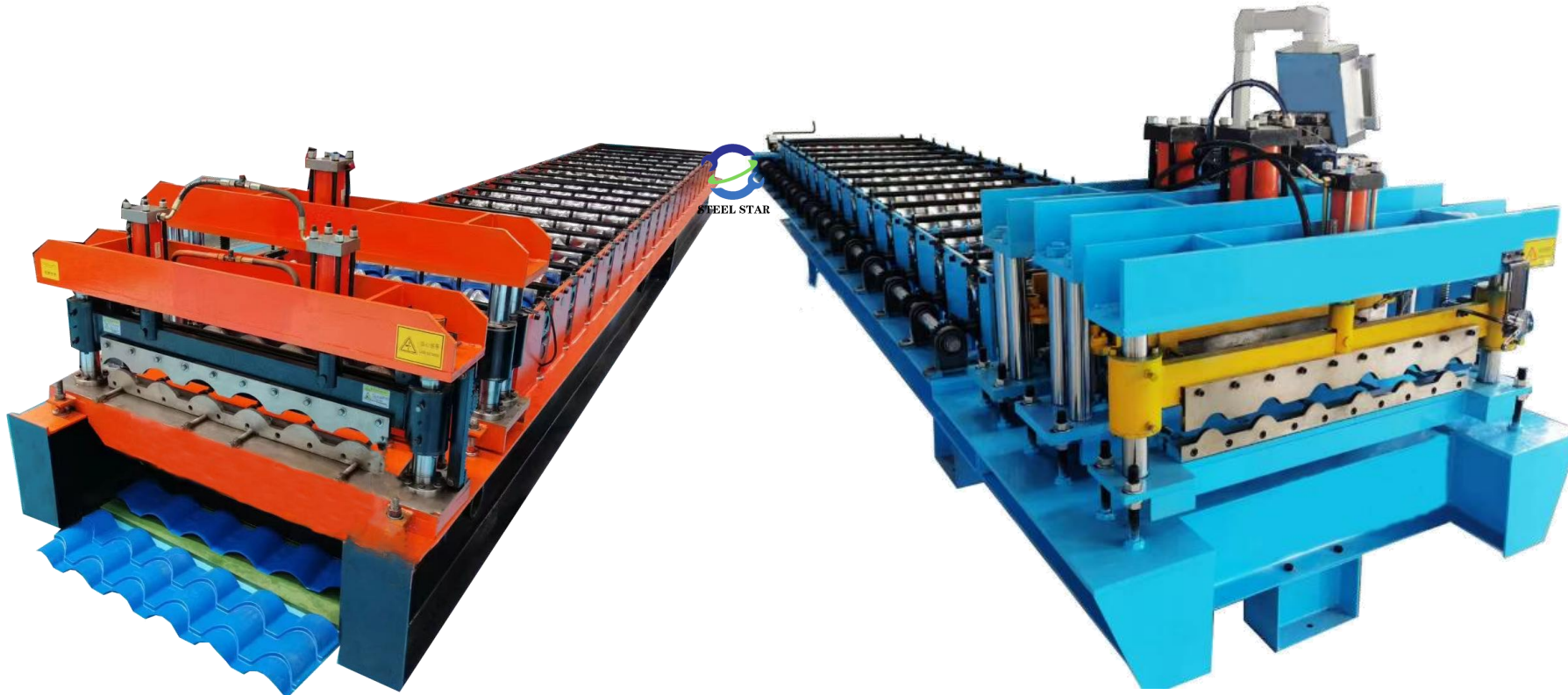

Scénarios d'application





STEEL STAR
www.greatforming.com

Catalogue de produits

1. Machine de formage de rouleaux de tôles de toiture

1-3 Machine de formage de rouleaux de tôles de toit en tuiles émaillées à modèle unique



Glazed roofing sheet

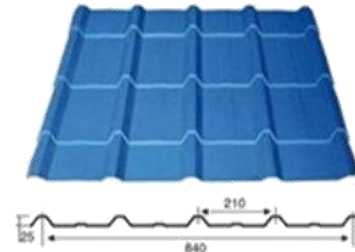

YX 25-210-840

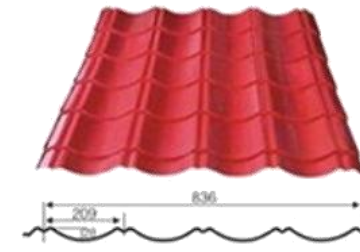

YX 28-29-836

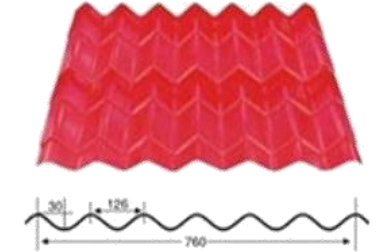

YX 30-126-760

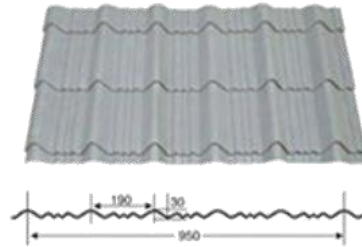

YX 30-190-950

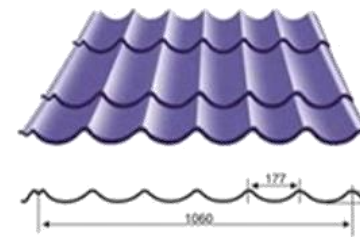

YX 30-177-1060

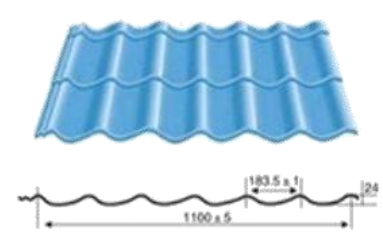

YX 24-183.5-1100

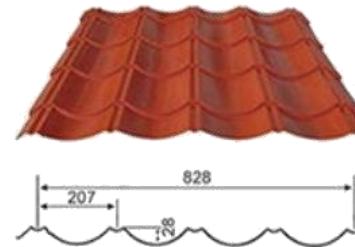

YX 28-207-828

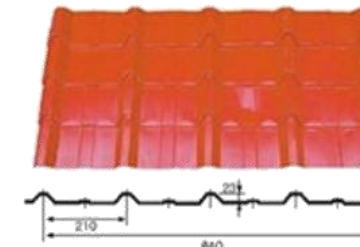

YX 28-207-828

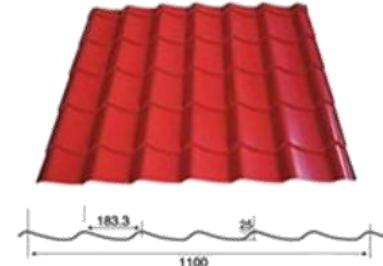

YX 25-183.3-1100



STEEL STAR
www.greatforming.com

Catalogue de produits

1. Machine de formage de rouleaux de tôles de toiture

1-4 Machine de formage de rouleaux de tôles de toit à double couche/double modèle

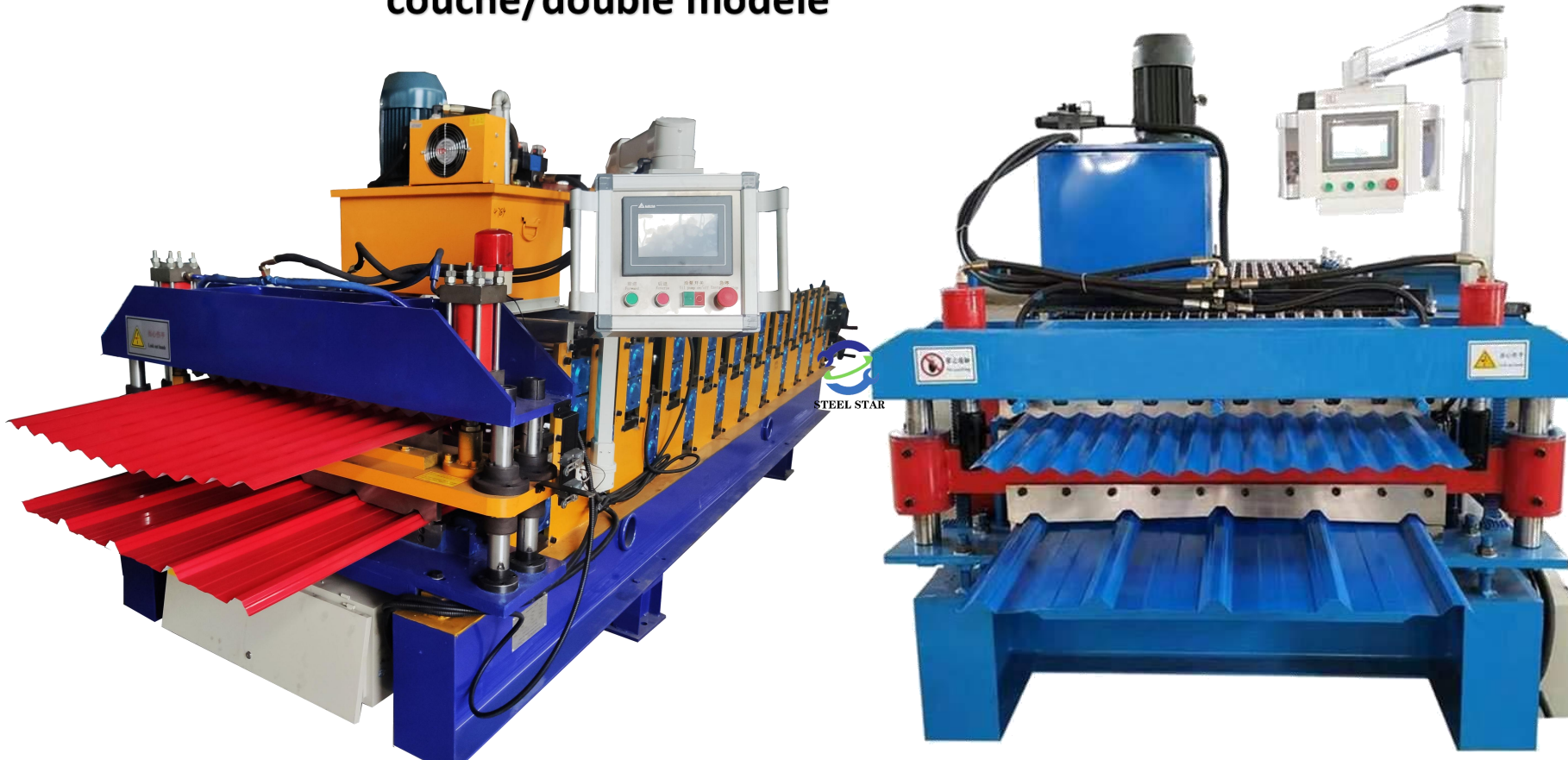

Scénarios d'application





STEEL STAR
www.greatforming.com

Catalogue de produits

1. Machine de formage de rouleaux de tôles de toiture

1-5 Machine de formage de rouleaux de tuiles émaillées à double couche/double modèle

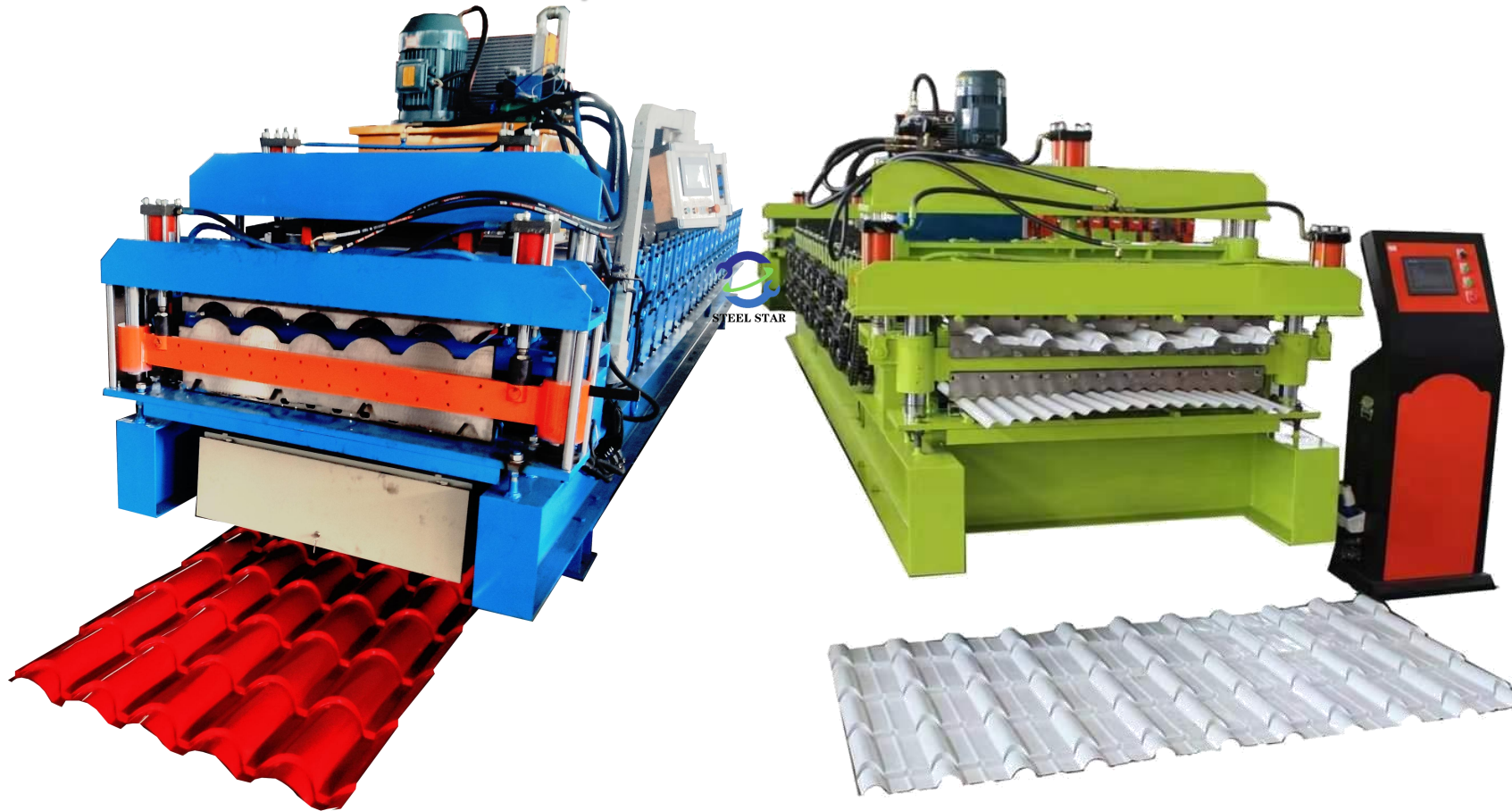

Scénarios d'application





STEEL STAR
www.greatforming.com

Catalogue de produits

1. Machine de formage de rouleaux de tôles de toiture

1-6 Machine de formage de rouleaux de tôles de toit à trois couches/trois modèles

Scénarios d'application





STEEL STAR
www.greatforming.com

Catalogue de produits

1. Machine de formage de rouleaux de tôles de toiture

1-7 Machine de cintrage de tôles de toit entièrement automatique

Scénarios d'application

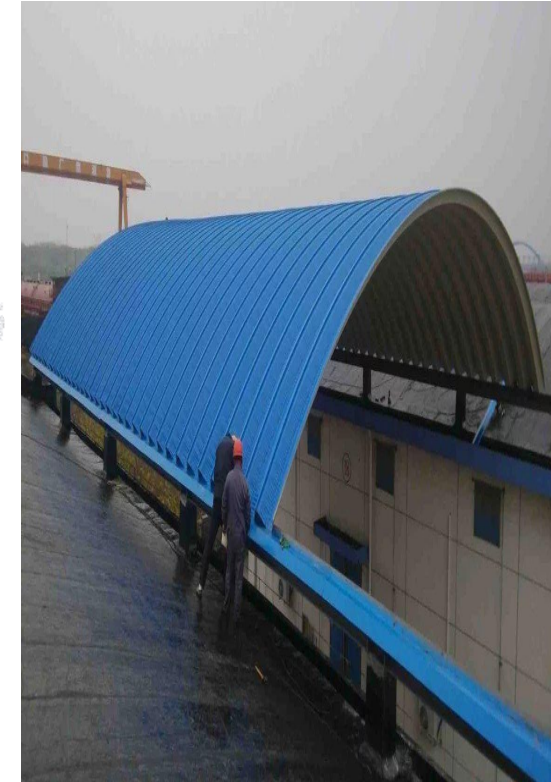
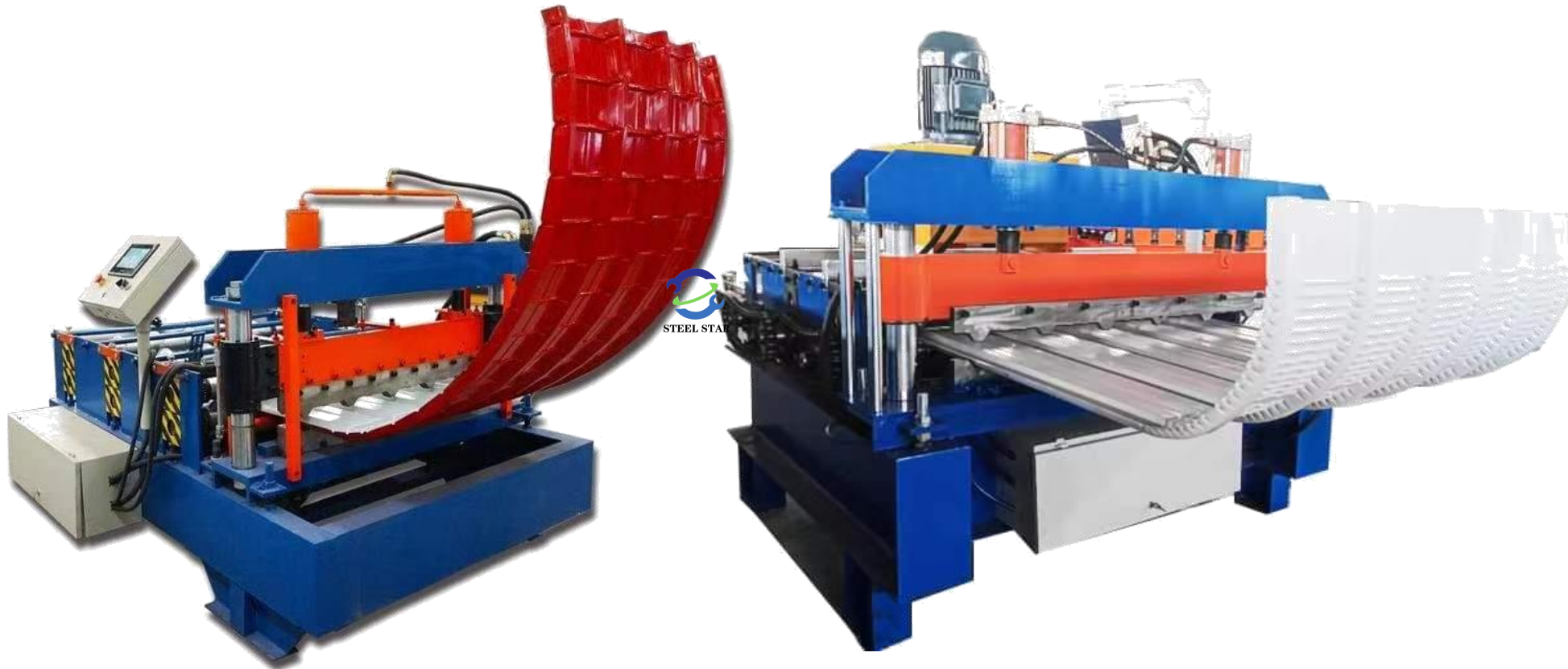

2-1 Machine de formage de rouleaux pour goujons et chenilles de quille légère C/U/V/Omega

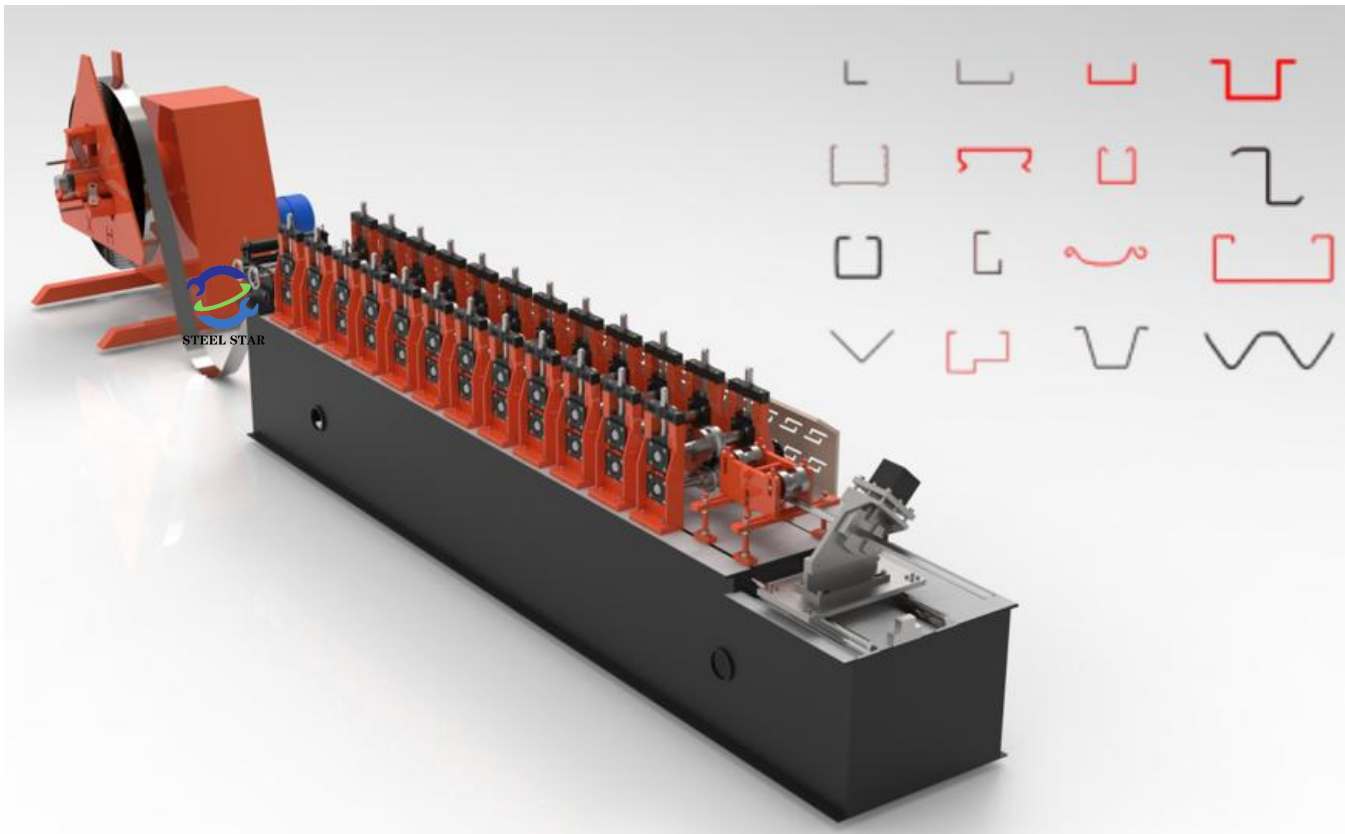

Grande vitesse

20 mètres – 150 mètres/minute

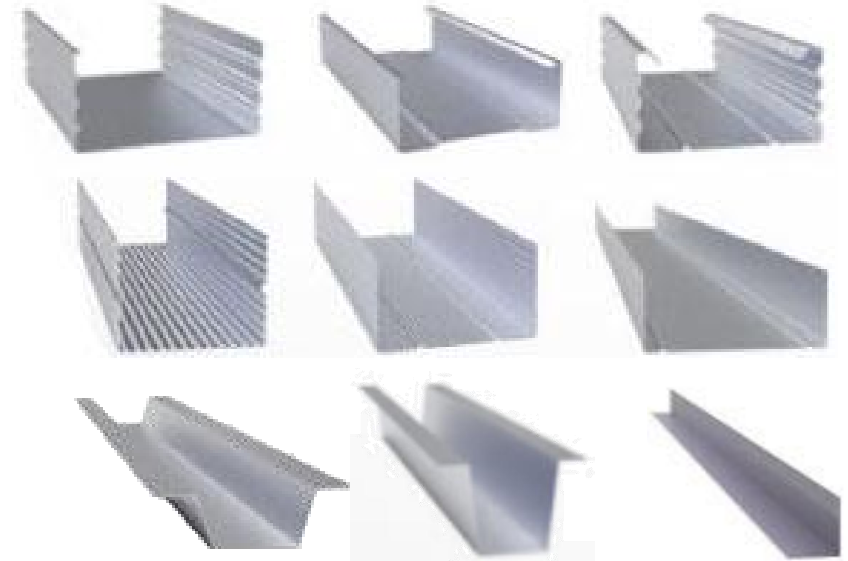



STEEL STAR
www.greatforming.com

Catalogue de produits

2. Machine de formage de quille en acier pour plafond/cloison

2-1 Machine de formage de rouleaux pour goujons et chenilles de quille légère C/U/V/Omega

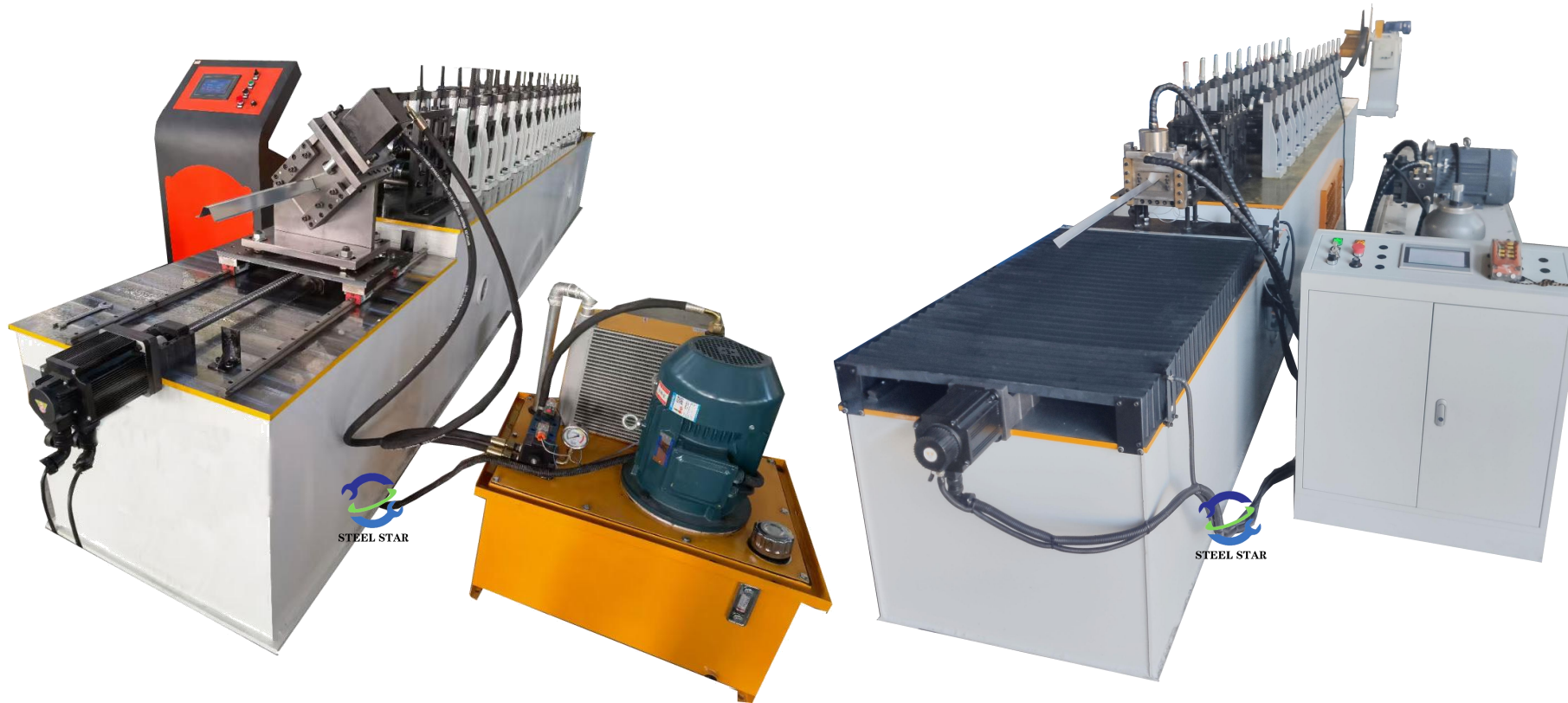

Scénarios d'application





Machine de formage de quilles légères à grande vitesse

STEEL STAR
www.greatforming.com

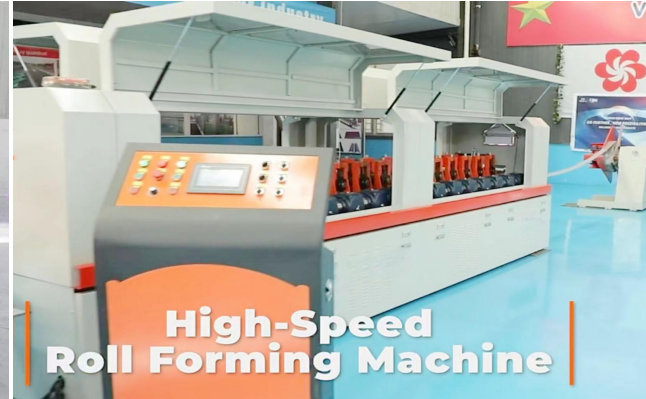

High-Speed Roll Forming Machine

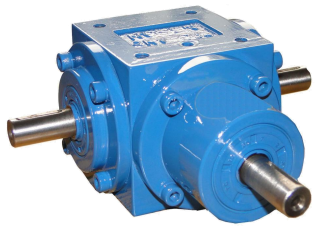

Structure de la boîte de vitesses

Grande vitesse 50 mètres-150 mètres/minute



Modèle C

Modèle U

Modèle V

Modèle Omega





STEEL STAR
www.greatforming.com

Catalogue de produits

3. Machine de formage de rouleaux de portes à volets

3-1 Machine de formage de rouleaux de portes à volets

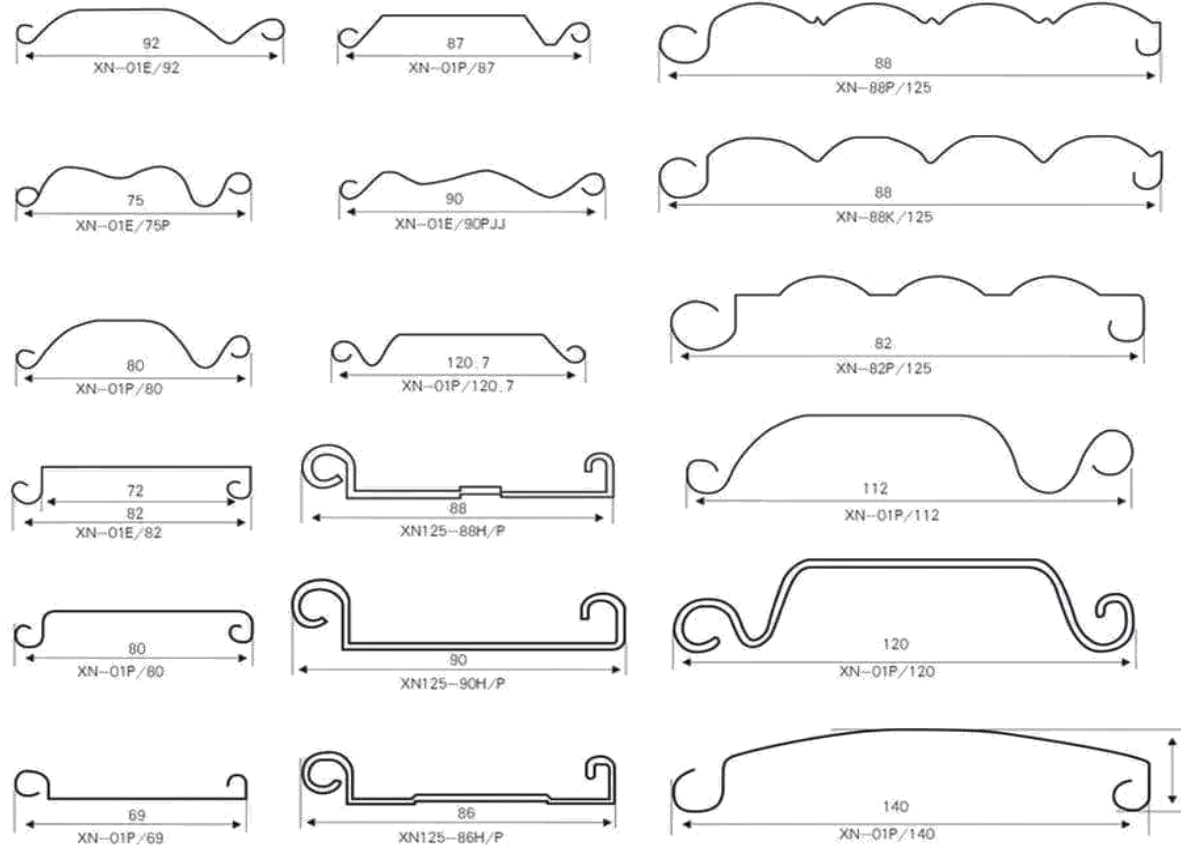
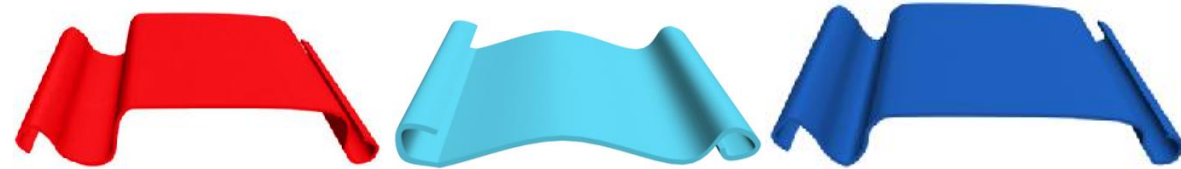
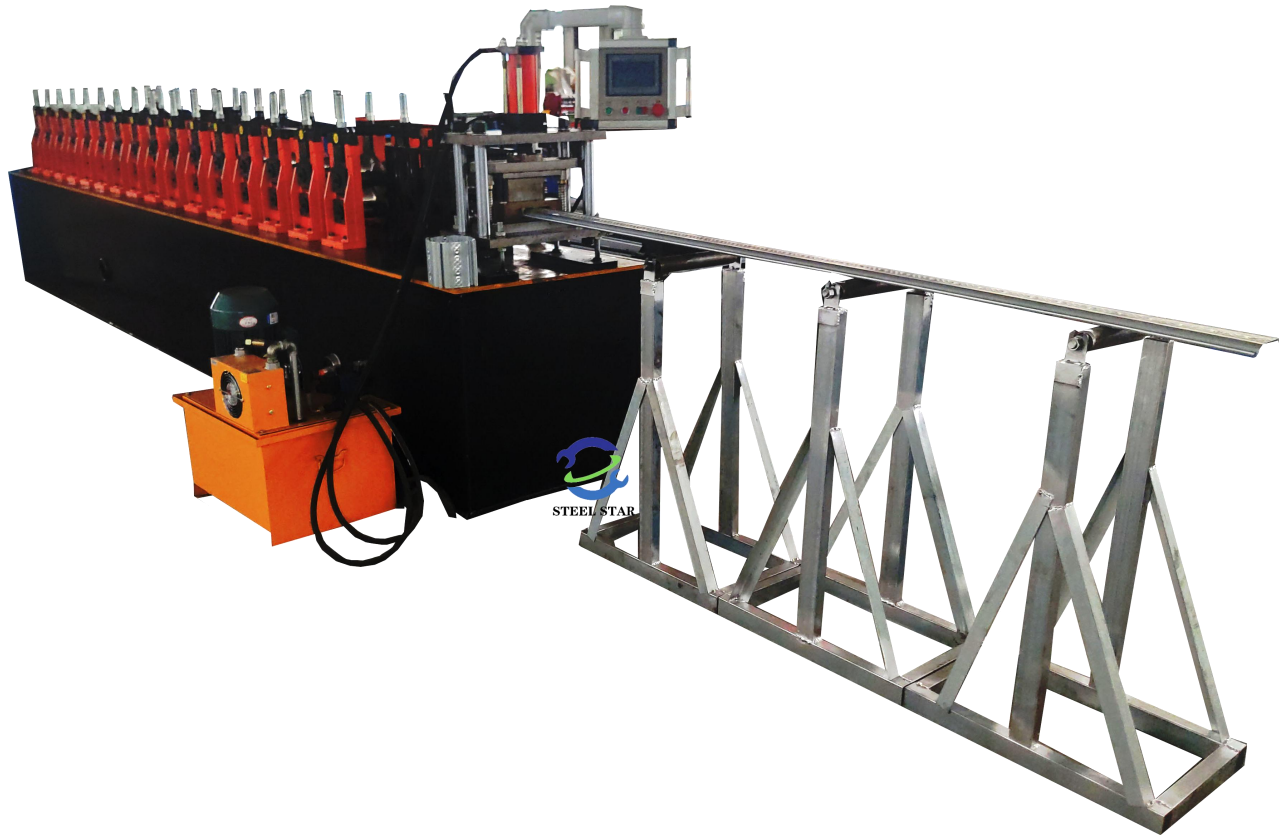



STEEL STAR
www.greatforming.com

Catalogue de produits

3. Machine de formage de rouleaux de portes à volets

3-1 Machine de formage de rouleaux de portes à volets

Scénarios d'application

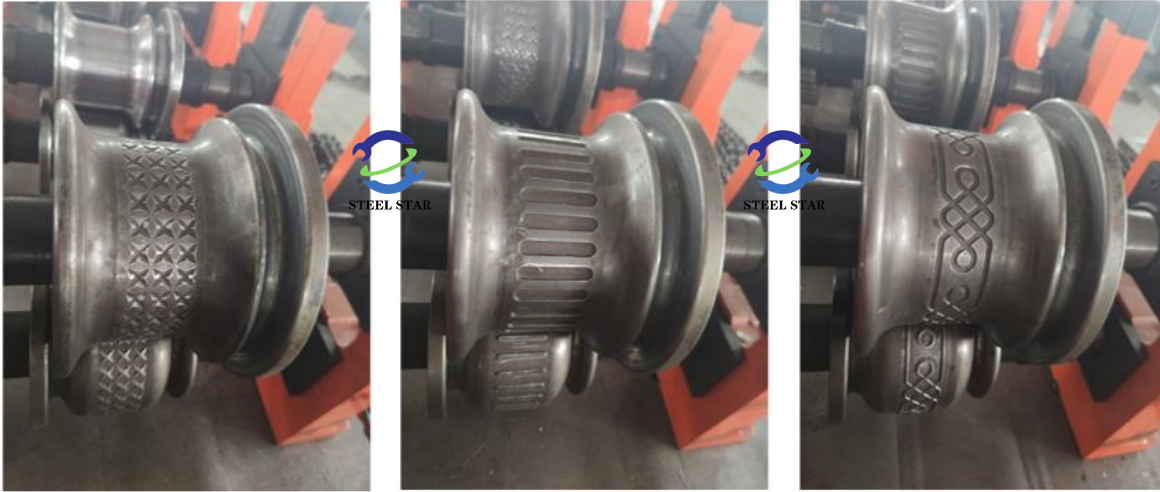



STEEL STAR
www.greatforming.com

Catalogue de produits

4. Machine de formage de rouleaux de pannes C/Z

4-1 Machine de formage de rouleaux de pannes C/Z

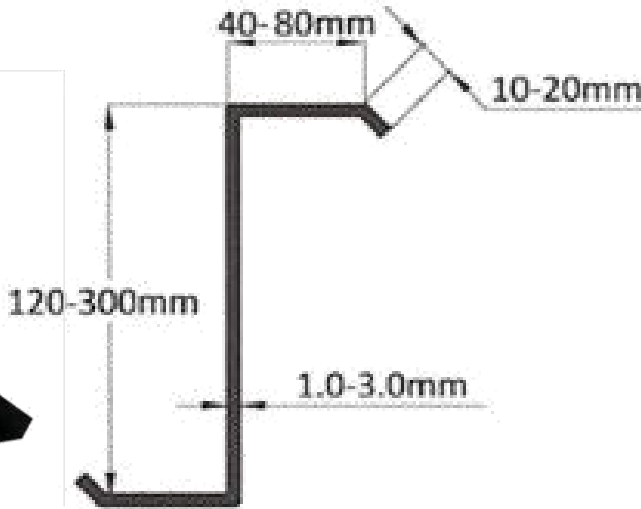
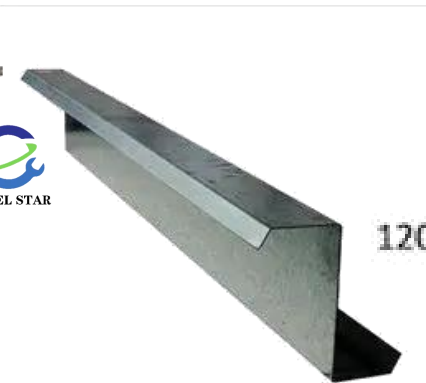
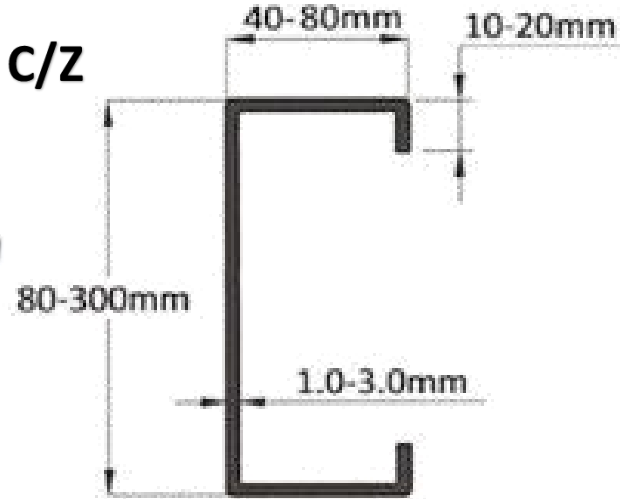
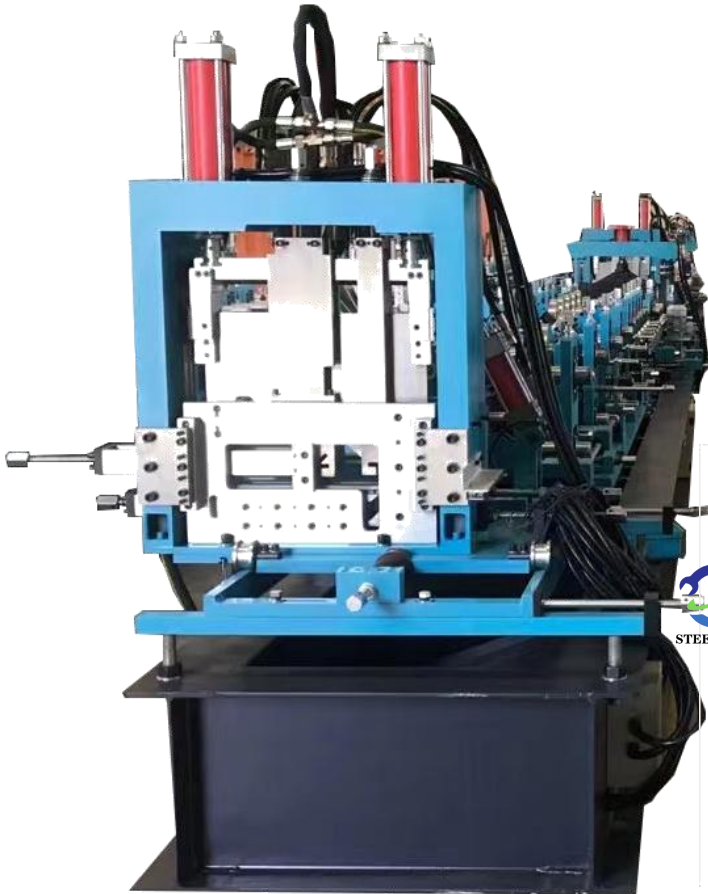

Scénarios d'application

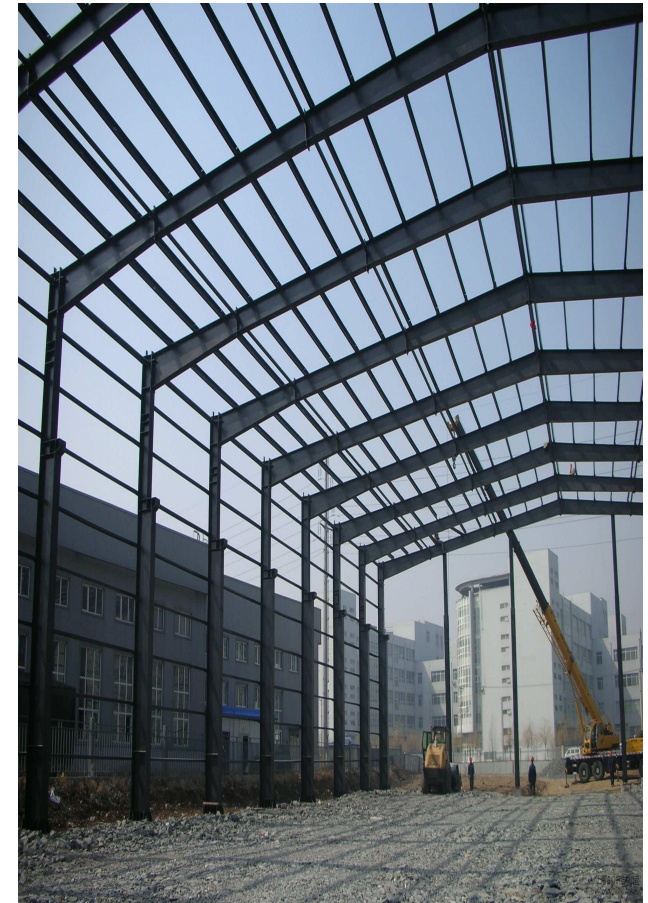



STEEL STAR
www.greatforming.com

Catalogue de produits

5. Machine de formage de rouleaux de faîtage

5-1 Machine de formage de rouleaux de faîtage



Scénarios d'application

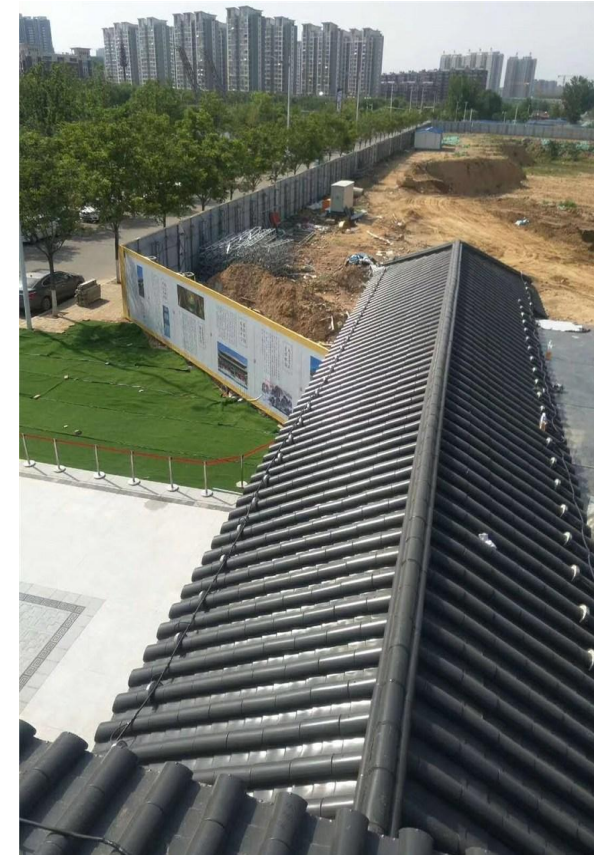



STEEL STAR
www.greatforming.com

Catalogue de produits

6. Machine de formage de rouleaux ondulés à tambour transversal

6-1 Machine de formage de rouleaux ondulés à tambour transversal

Scénarios d'application

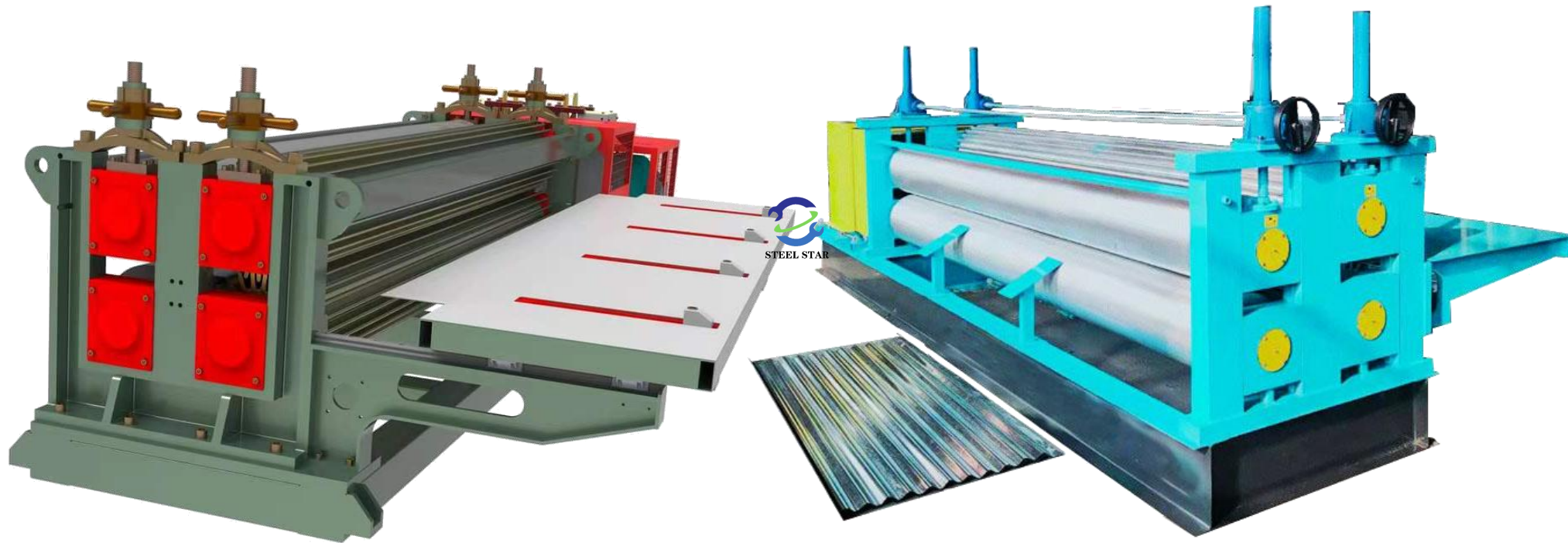



STEEL STAR
www.greatforming.com

Catalogue de produits

7. Machine de formage de rouleaux de plancher en acier porteur

7-1 Machine de formage de rouleaux de plancher en acier porteur

Scénarios d'application





STEEL STAR
www.greatforming.com

Catalogue de produits

8. Machine de formage de tôles d'acier côté automobile

8-1 Machine de formage de tôles d'acier côté automobile

Scénarios d'application

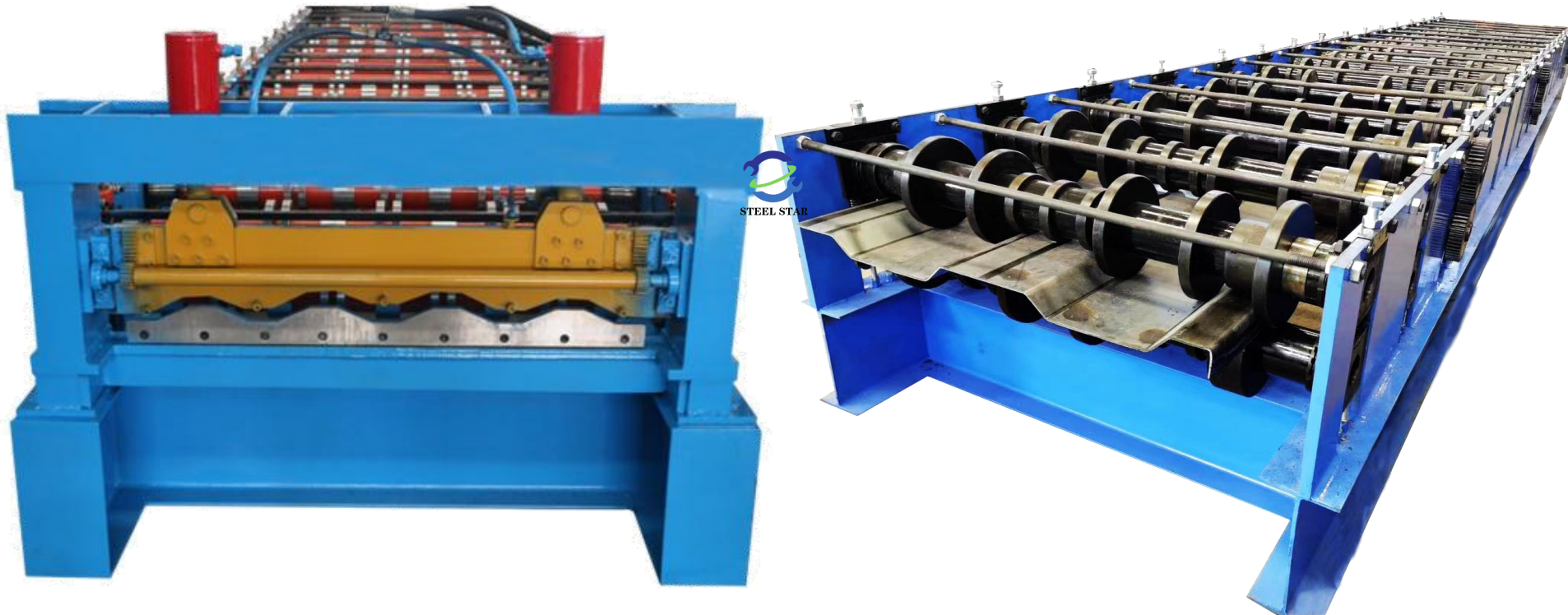



STEEL STAR
www.greatforming.com

Catalogue de produits

9. Machine de formage de rouleaux de gouttières et descentes pluviales

9-1 Machine de formage de rouleaux de gouttières et descentes pluviales

Scénarios d'application

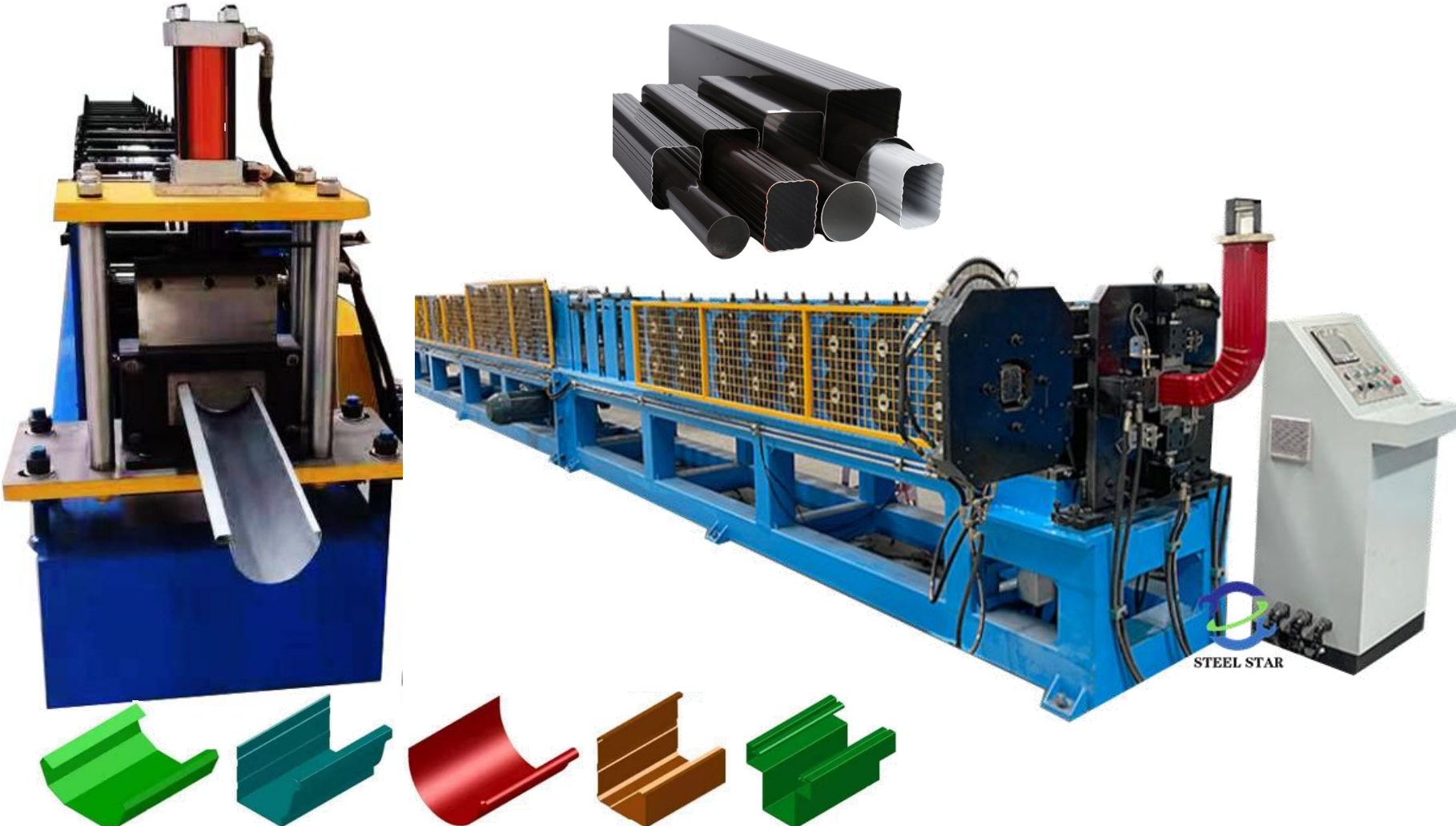



STEEL STAR
www.greatforming.com

Catalogue de produits

10. Machine de formage de rouleaux de cadre de villa à quille légère

10-1 Machine de formage de rouleaux de cadre de villa à quille légère

Scénarios d'application



Vertex **BD**

41
89

41
140

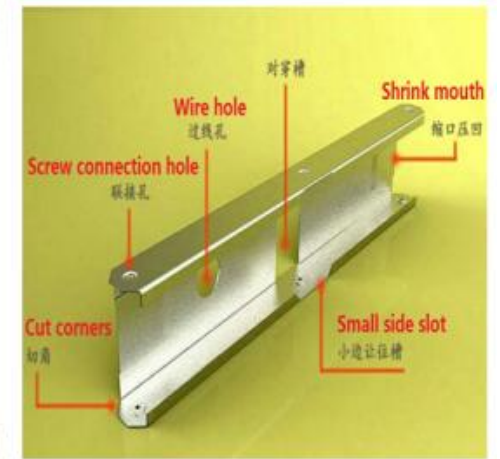



STEEL STAR
www.greatforming.com

Catalogue de produits

11. Machine de formage de rouleaux de plaques de garde-corps

11-1 Machine de formage de rouleaux de plaques de garde-corps

Scénarios d'application

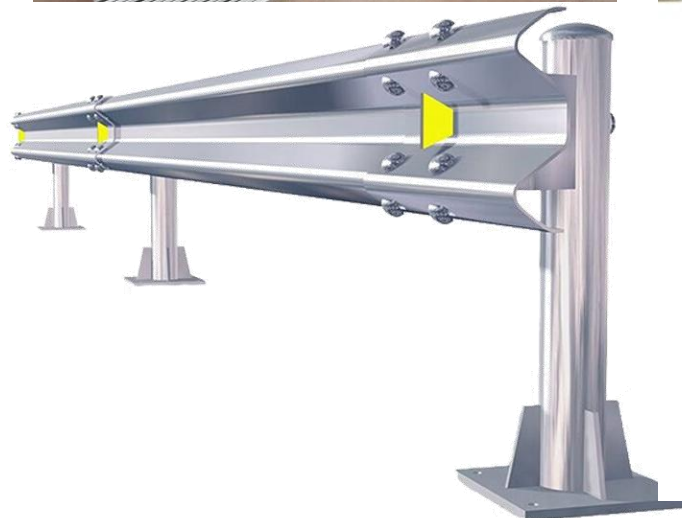
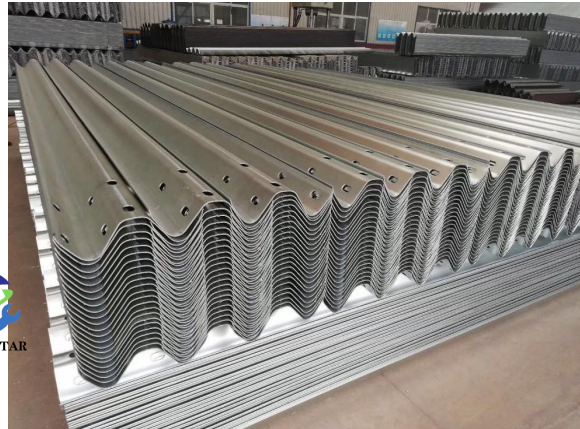



STEEL STAR
www.greatforming.com

Catalogue de produits

12. Ligne de production de panneaux composites pour toitures en mousse / laine de roche

12-1 Ligne de production de panneaux composites pour toitures en mousse / laine de roche

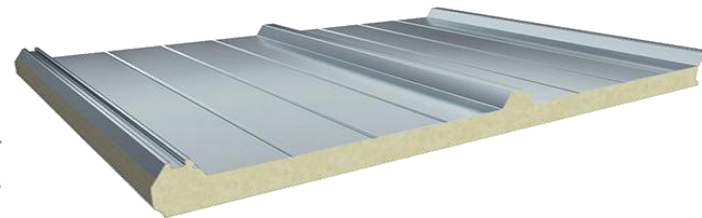
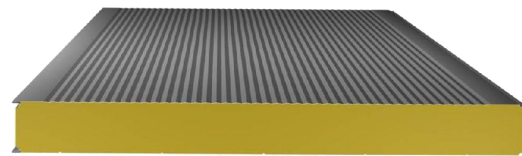
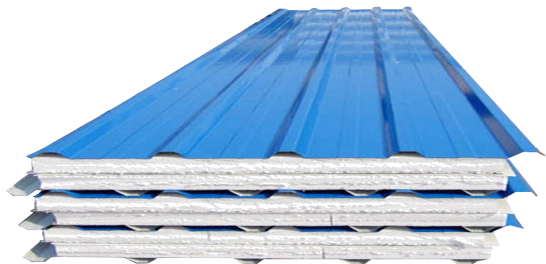

Scénarios d'application





STEEL STAR
www.greatforming.com

Catalogue de produits

13. Machine de fabrication de panneaux de toiture à dérouleur / empileur automatique

13-1 Machine de fabrication de panneaux de toiture à dérouleur / empileur automatique

Scénarios d'application

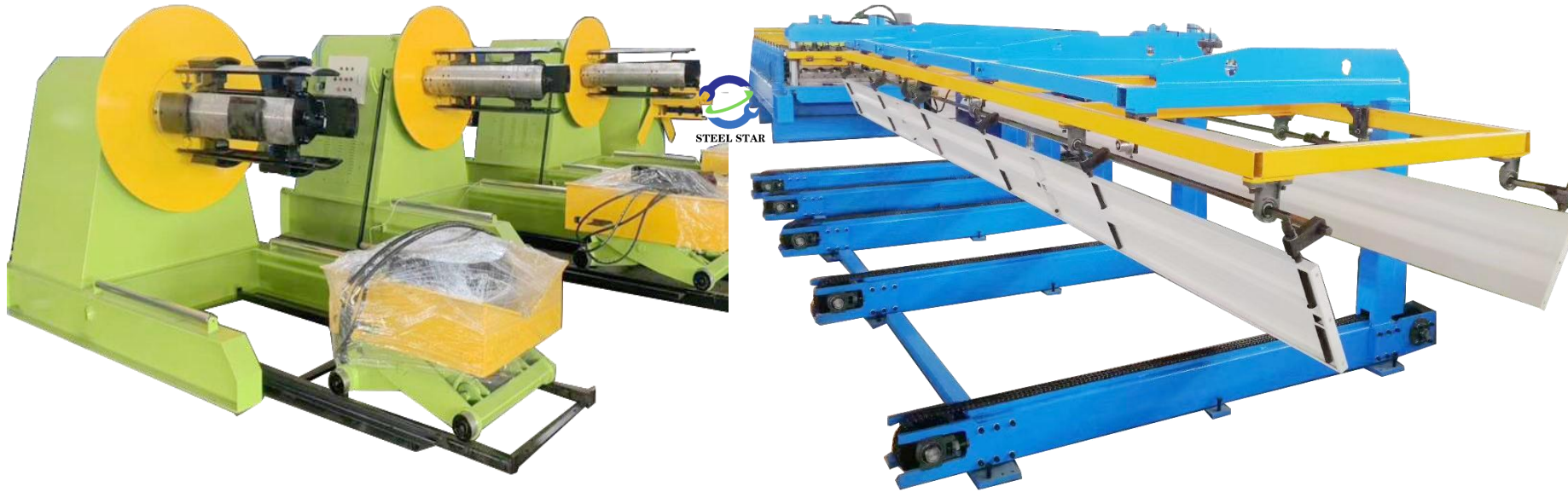



STEEL STAR
www.greatforming.com

14-1 Machine à cisailier / à cintrer

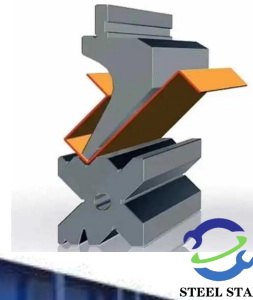
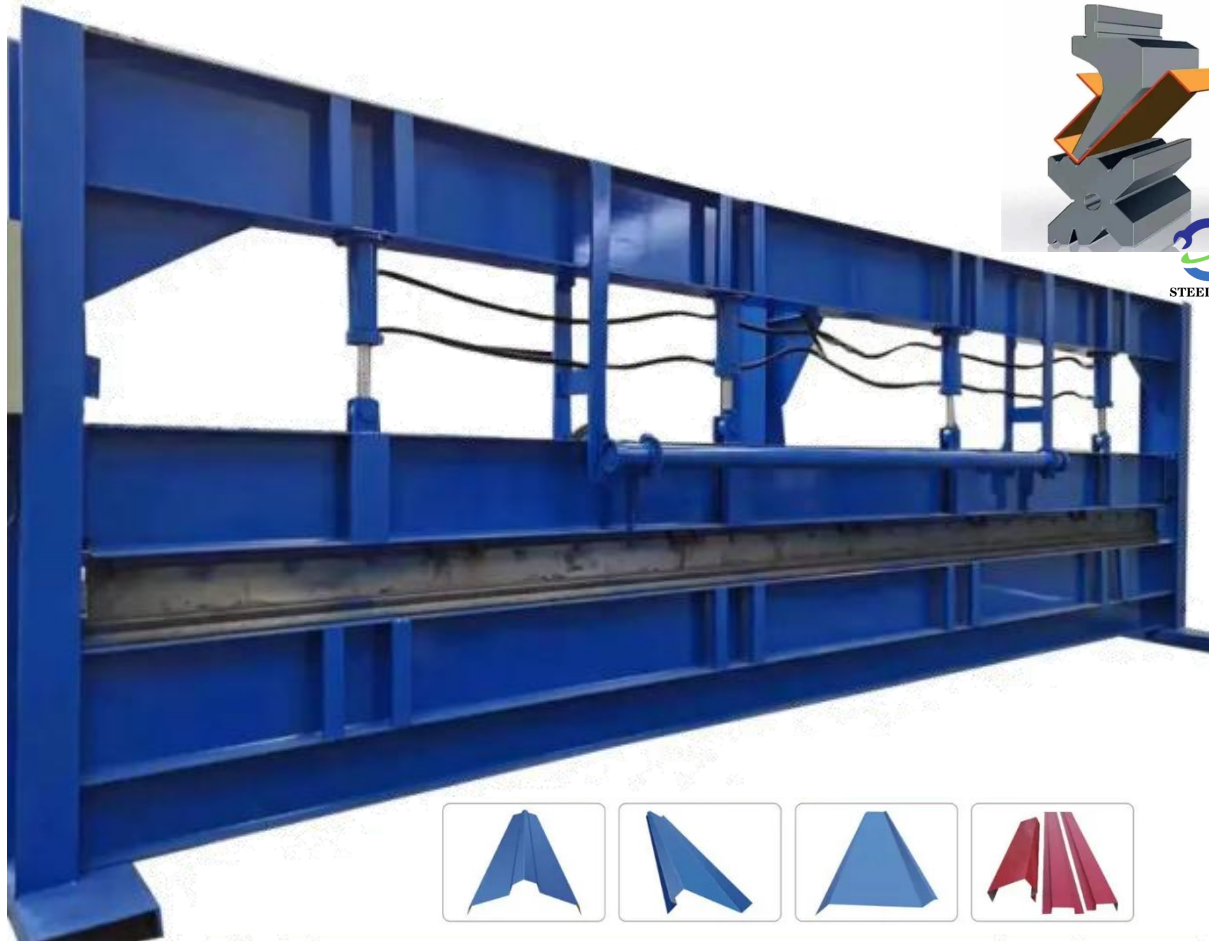



STEEL STAR
www.greatforming.com

Catalogue de produits

15. Machine de ligne de refendage de bobines d'acier

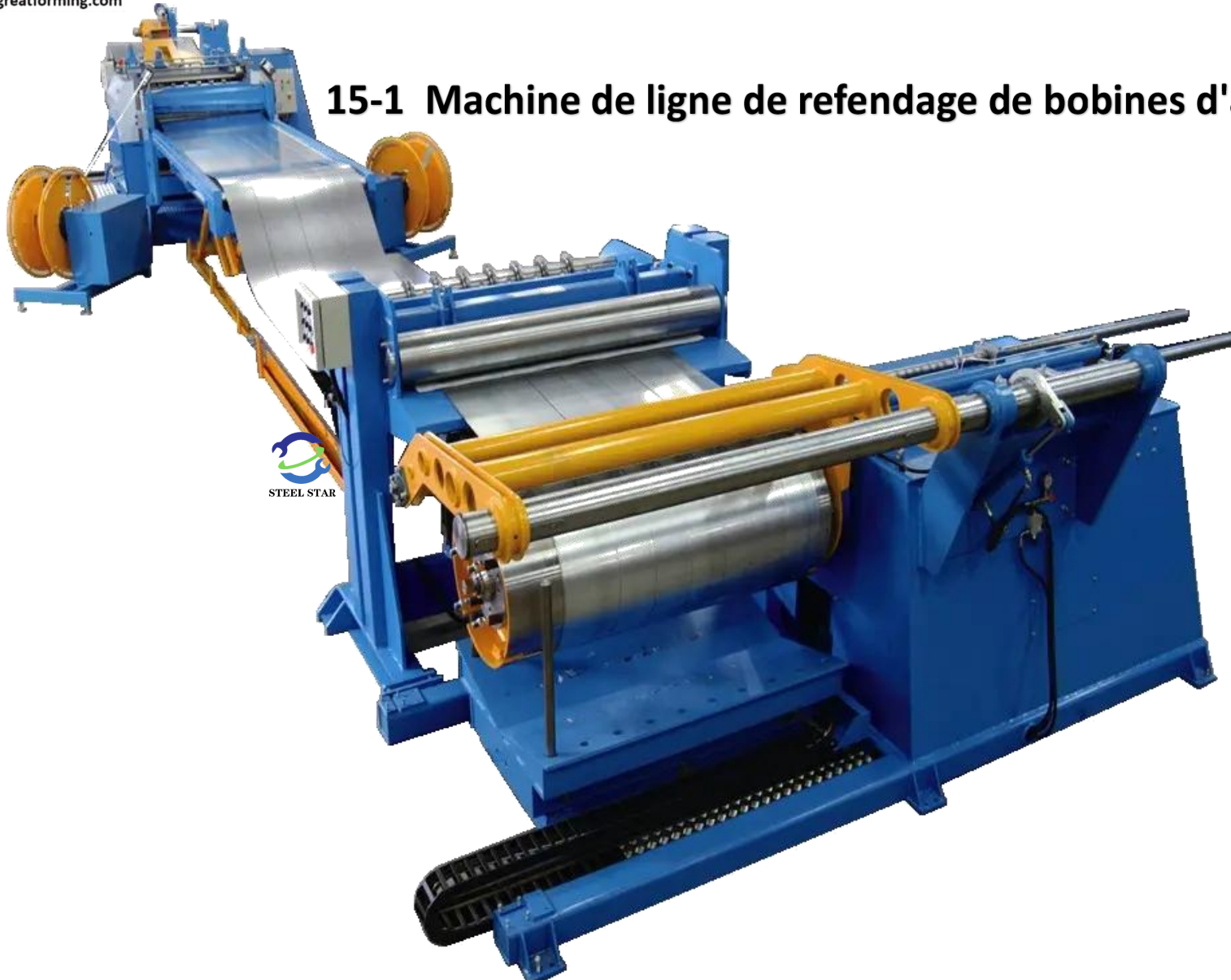

15-1 Machine de ligne de refendage de bobines d'acier



Scénarios d'application

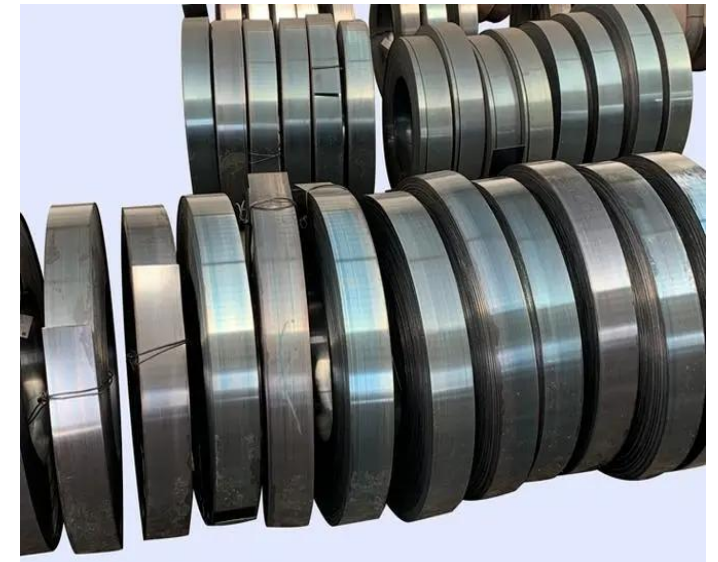
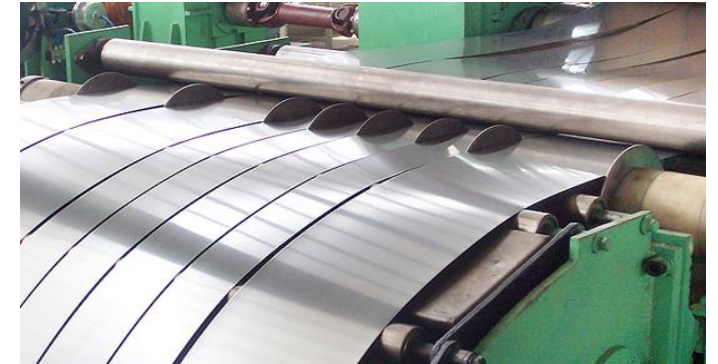



STEEL STAR
www.greatforming.com

Catalogue de produits

16. Machine de formage de rouleaux de supports solaires de supports solaires

16-1 Machine de formage de rouleaux de supports solaires



Scénarios d'application





STEEL STAR
www.greatforming.com

Catalogue de produits

17. Machine de fabrication de tubes en acier en acier

17-1 Machine de fabrication de tubes en acier

Scénarios d'application

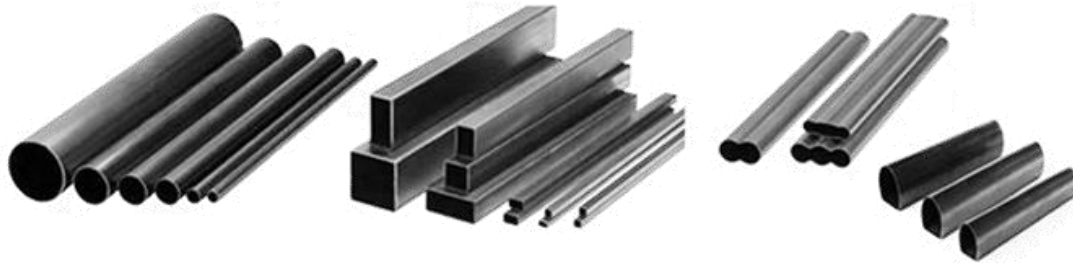
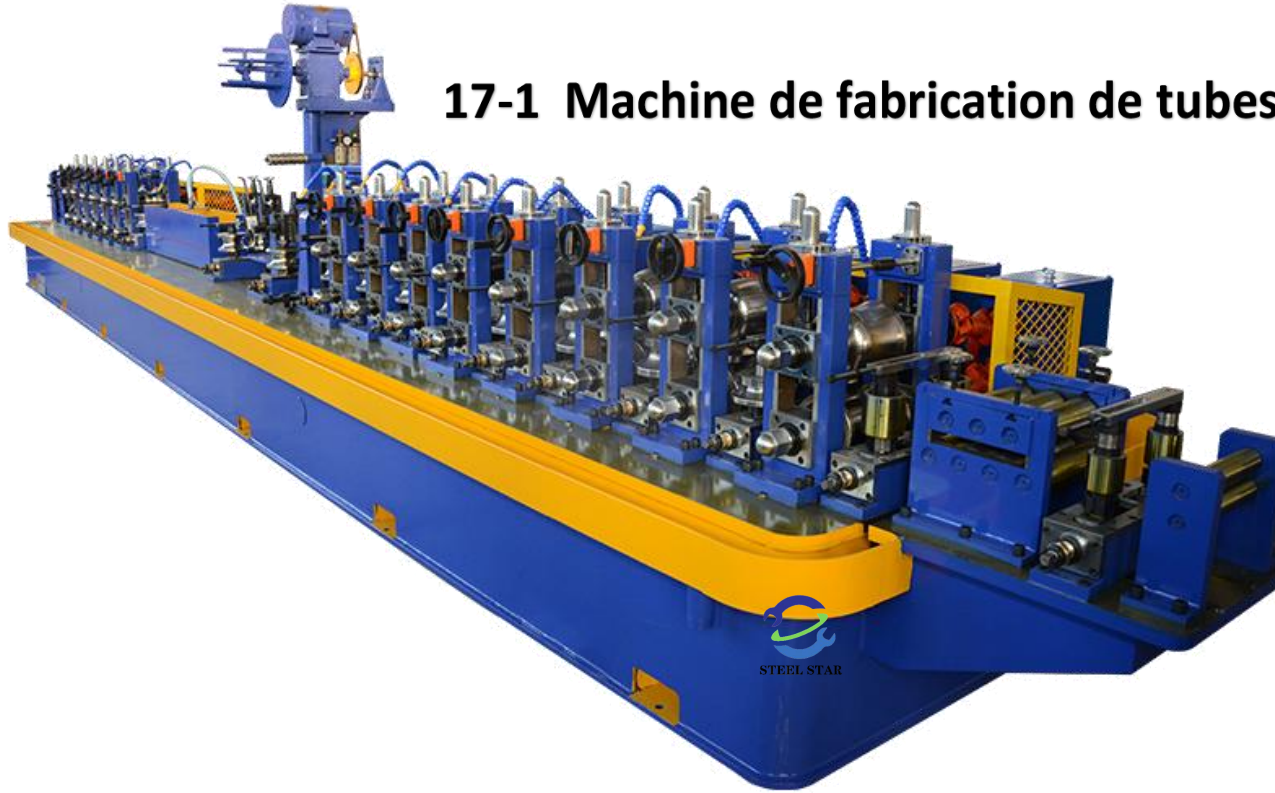

18-1 Différents produits peuvent être personnalisés

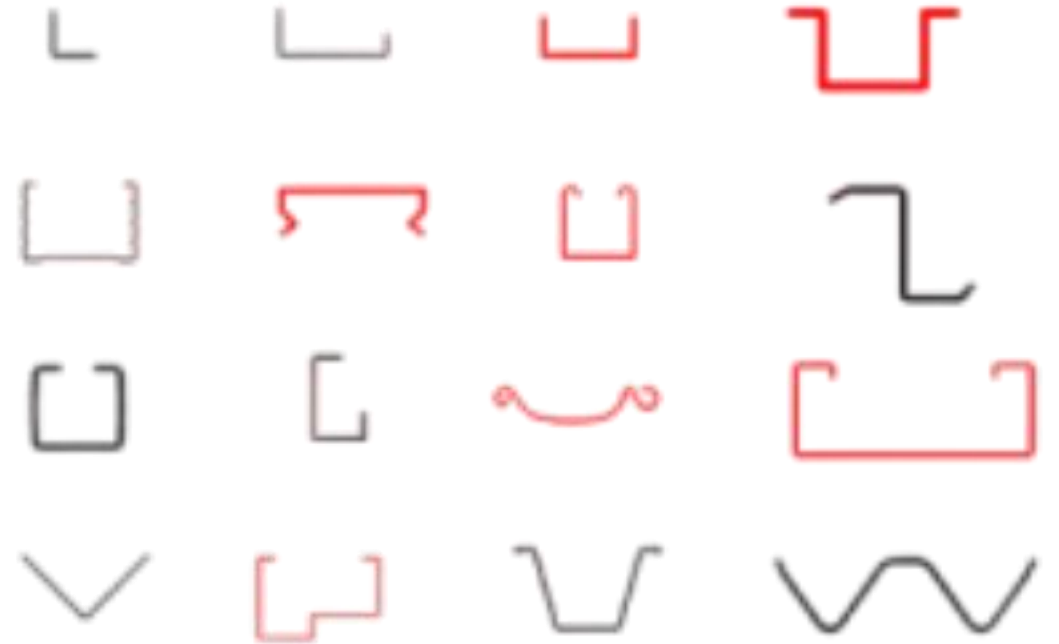
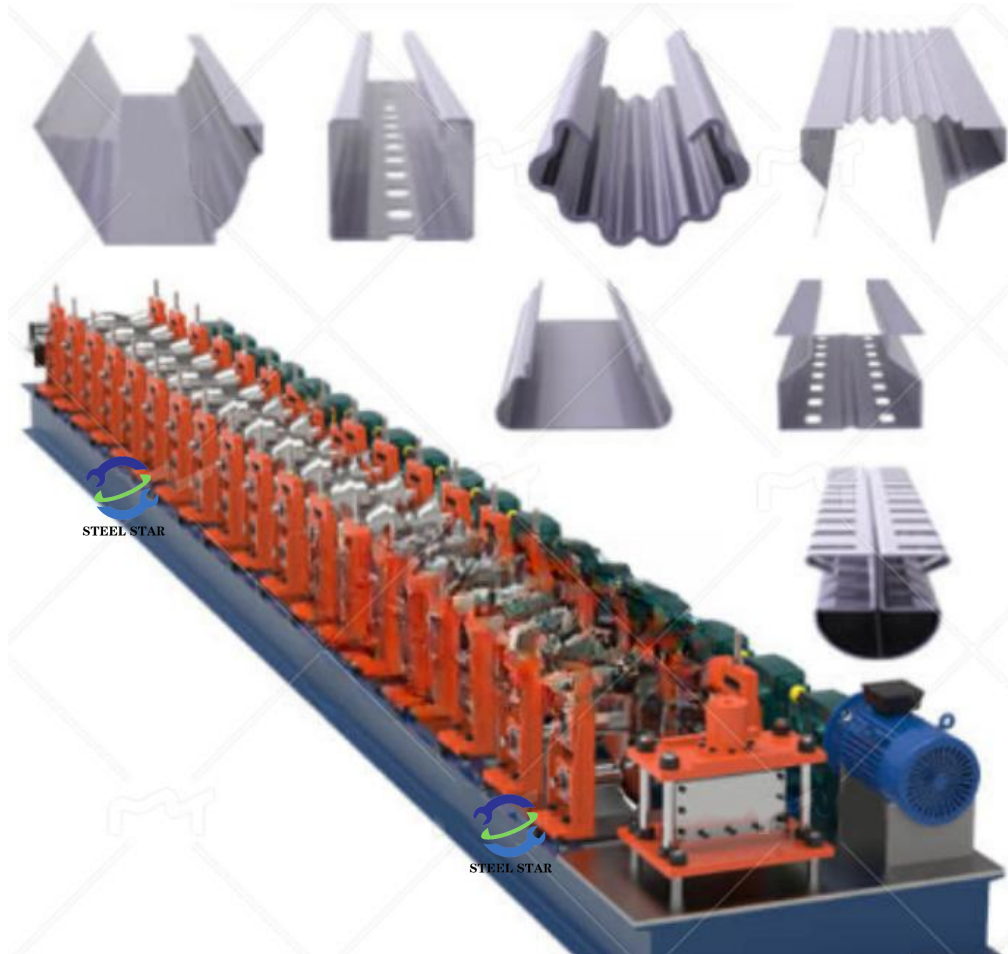



STEEL STAR
www.greatforming.com

Expédition à l'étranger





STEEL STAR
www.greatforming.com

Service



Notre service client vous aidera à résoudre tout problème lié au système : notre service est disponible 24 heures sur 24 pendant les jours ouvrables. Nous répondrons à vos questions rapidement et de manière fiable.

Si nécessaire, nous enverrons du personnel professionnel de débogage et d'installation d'équipements qui pourra se rendre dans votre ville et vous aider à installer l'équipement sur place.





STEEL STAR
www.greatforming.com

Contactez-nous



+86 15075780050

WhatsApp Wechat

Email : sam@greatforming.com

Official website(Site officiel) : www.greatforming.com



China



Beijing		1 Hour	
		4 Hour	
Tianjin		0.5 Hour	
		2.5 Hour	
Jinan		1 Hour	
		3 Hour	